

SPECIFICATION	
Body :FRP/PVC	MAX. PRESSURE: 50 PSI *
Basket: 304 SS, 1/8" Perf	MAX. TEMPERATURE: 140 Deg F
Basket Matl: flg-12 GA/ Perf-18 GA	BASKET/PIPE AREA: 12.5 : 1
Gasket: Neoprene	Open Basket Area: 5 : 1
Inlet: 6" 150# ANSI Flange	Cover: 1" Acrylic With 1/2" Vent
Outlet: 4" 150# ANSI Flange	Lid Closer: Tee Handles 304 SS

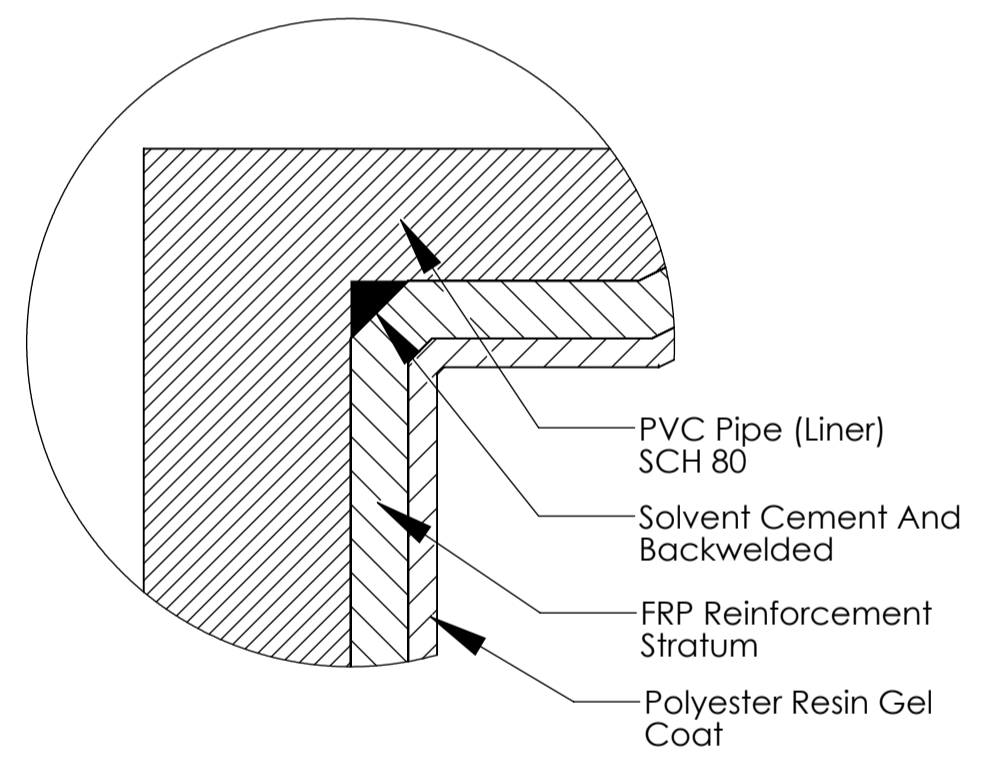
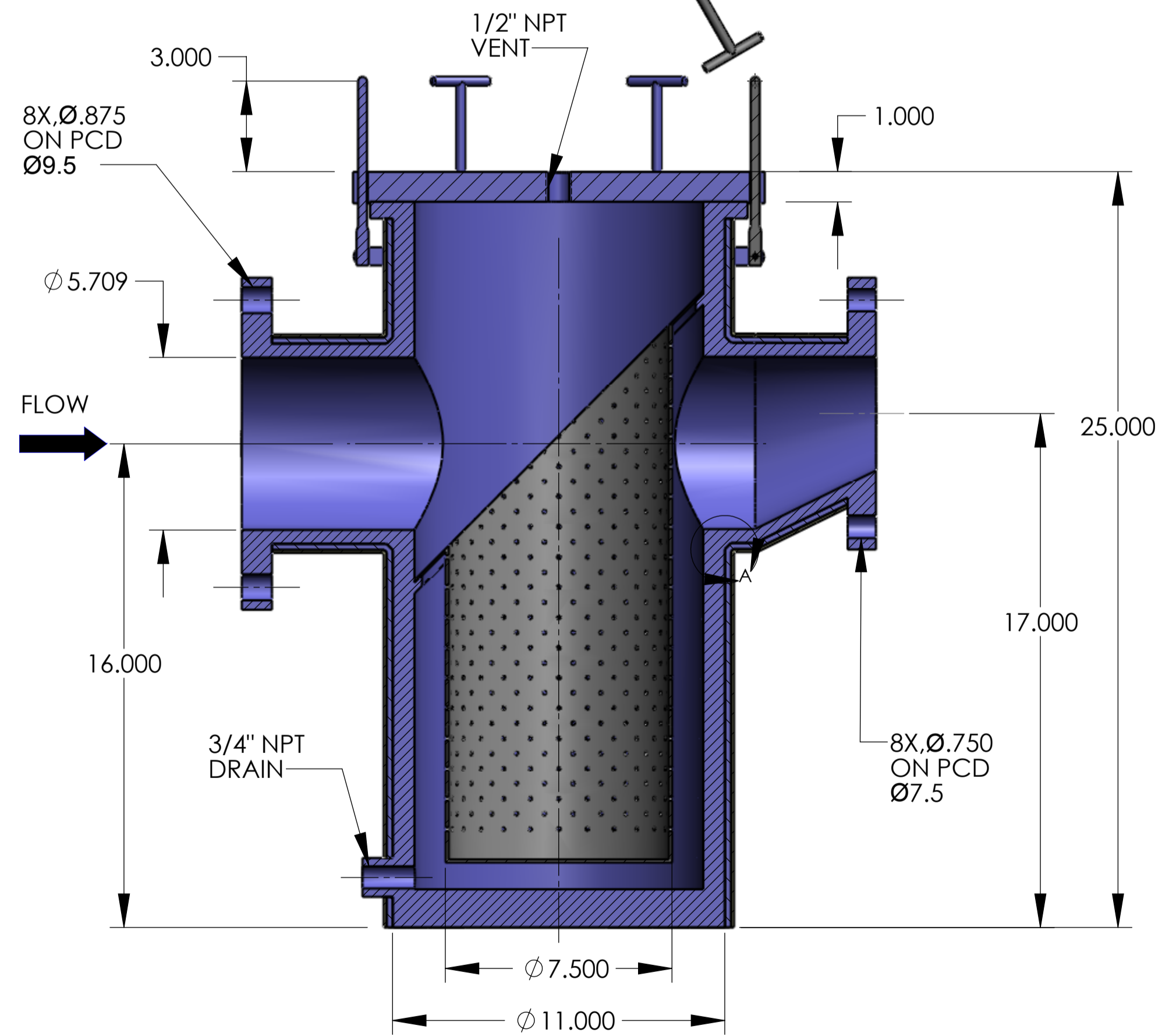
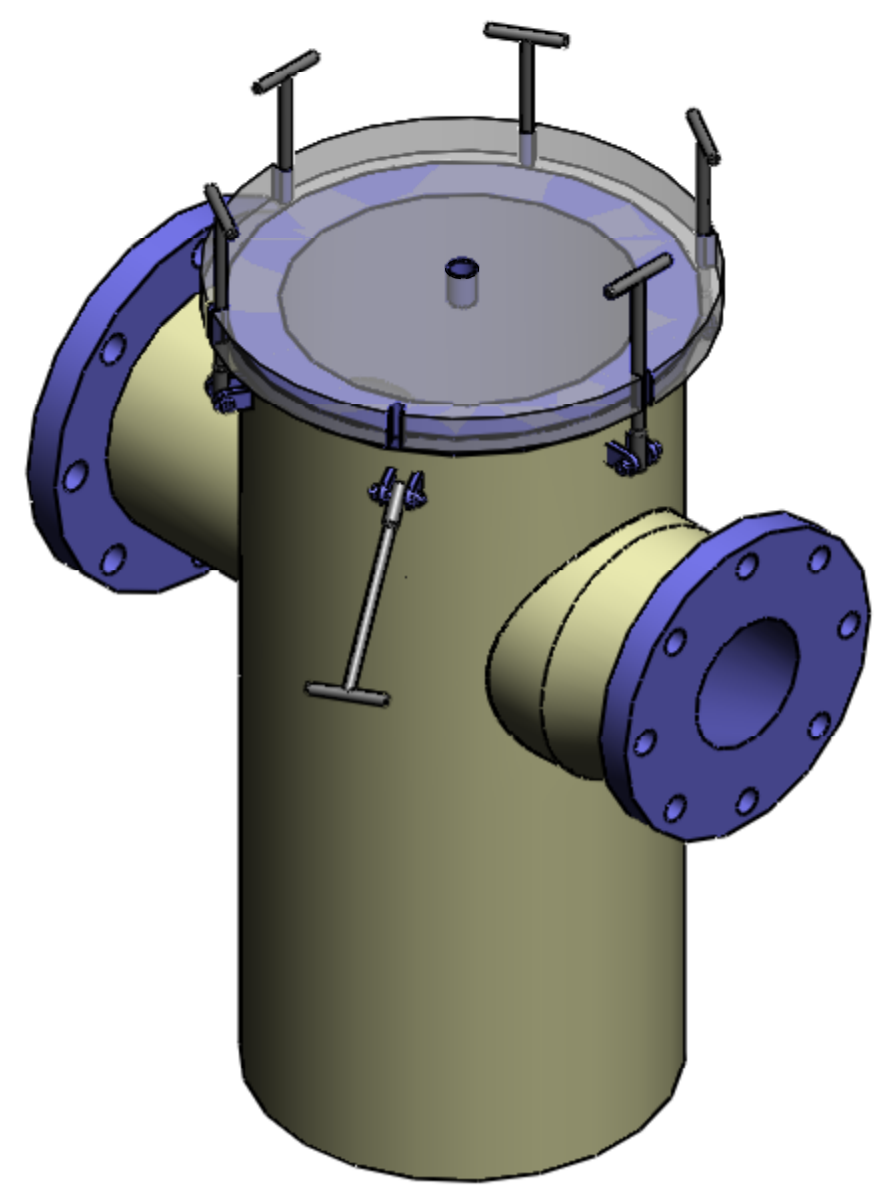
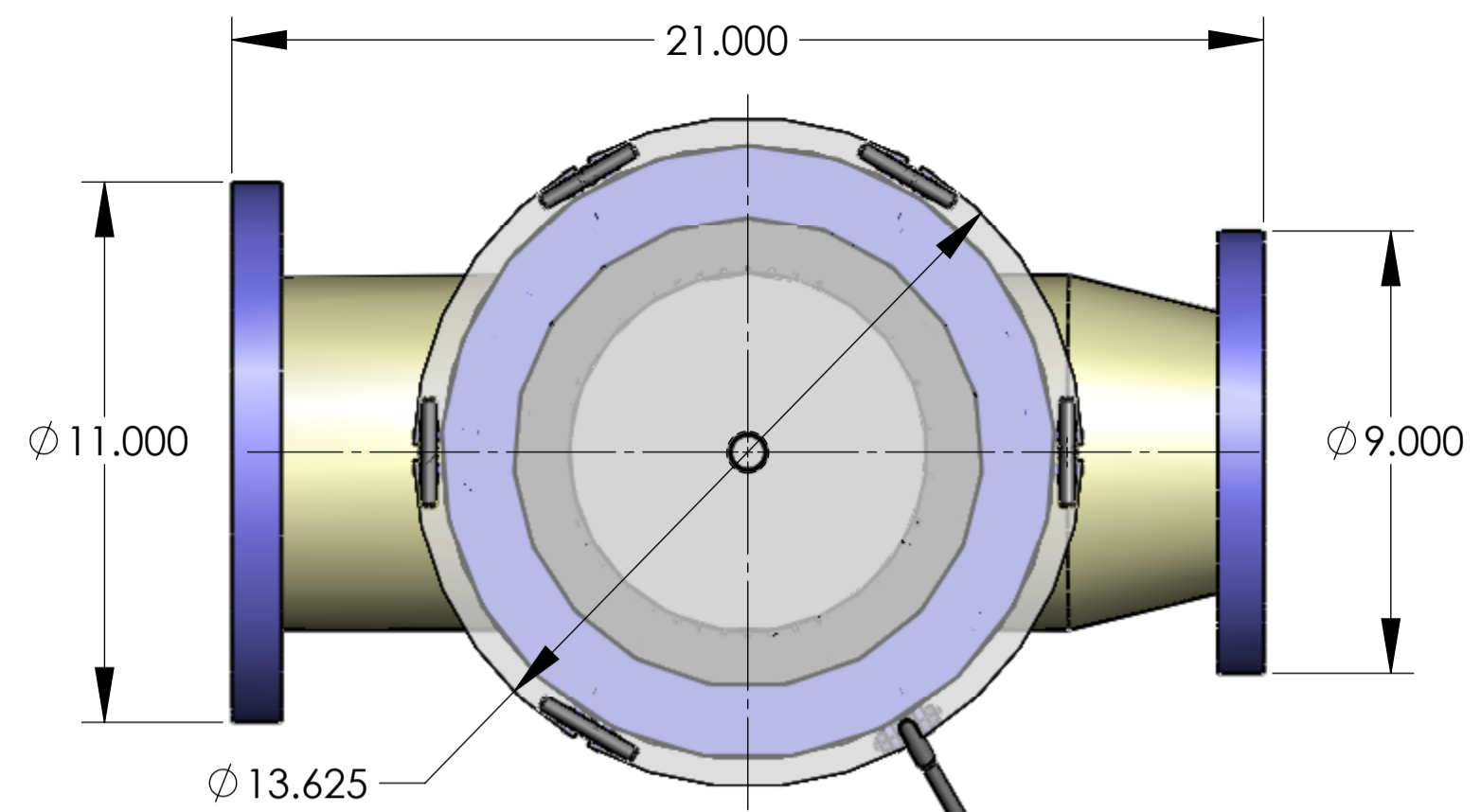

DETAIL A
SCALE 1.5 : 1

FLUIDTROL PROCESS TECHNOLOGIES, INC. HUNTSVILLE, AL 35811	
DRAWN: SS	RSW SERIES AQUATIC STRAINER 6"X4"
DATE: 11-1-10	

This drawing represents the Design & engineering efforts of Fluidtrol process Technologies, Inc. it is loaned in confidence and is not to be reproduced or used in anyway detrimental to Fluidtrol process Technologies, Inc Without Written Permission

MODEL: RSW116106431

DRWG RSW116106431 852-0664SC