

Lid Closer Options



Bolted



Victualic

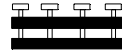

Tee Handle

* Cover Selection Depends Upon Pressure Rating

SPECIFICATIONS

Body: 304 Stainless Steel SCH 10	Max. Press: 50 PSI. *
Basket: 304 SS 1/8" Perf	Max. Temp: 140 Deg. F
Basket Mtr'l: Fig.-12 GA / Perf-16 GA	Basket / Pipe Area: 8.67 : 1
Gasket: Neoprene	Open Basket Area = 3.5 : 1
Inlet: 12" 150# Ansi Flange	Cover : 1.25" Acrylic With 1/2" Vent
Outlet: 12" 150# Ansi Flange	Lid Closer: Tee Handles 304 SS

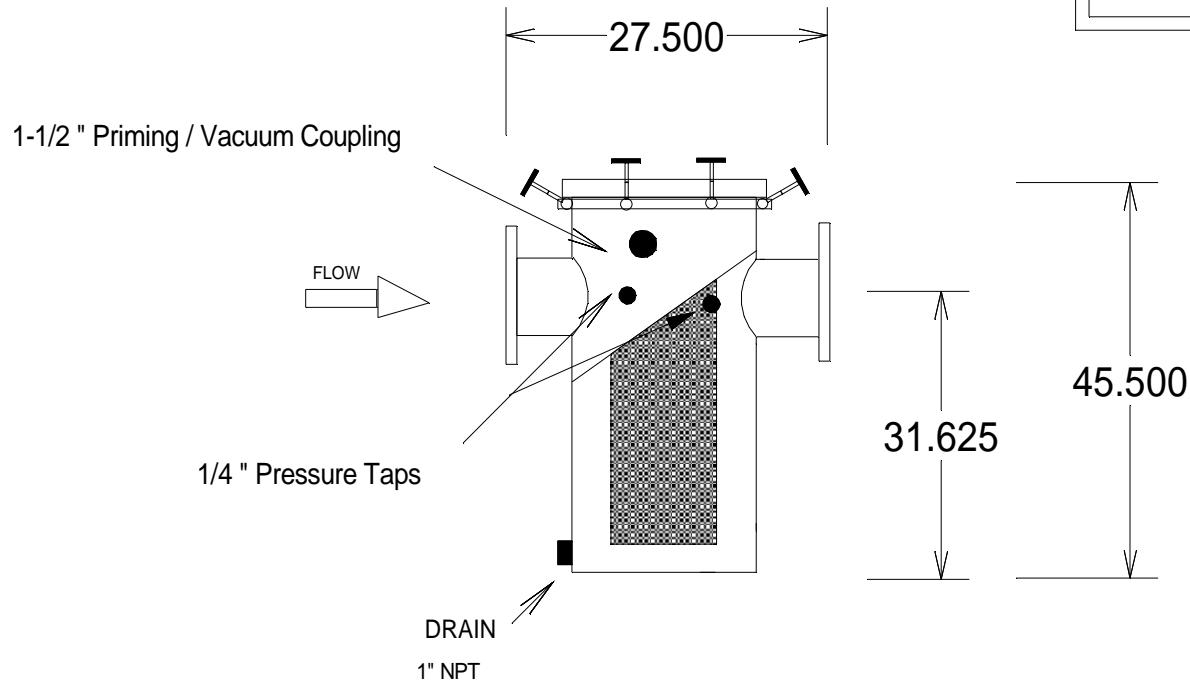

This drawing represents the design & engineering efforts of Fluidtrol Process Technologies, Inc. it is loaned in confidence and is not to be reproduced or used in any way detrimental to Fluidtrol Process Technologies, Inc without written permission.

FLUIDTROL PROCESS TECHNOLOGIES, INC.
 PELHAM, AL 35124

DRWN: TT
 DATE:
 5-9-07

SW - SS SERIES AQUATIC STRAINER
12" X 12"

MODEL: SW166112031

DRWG: SW166112031

650-0612